



Printer/Scanner Kit Type 1232

Operating Instructions Printer Reference 1



-
- 1 Getting Started
 - 2 Installing the Printer Driver and Software

Introduction

This manual describes detailed instructions on the operation and notes about the use of this machine. To get maximum versatility from this machine all operators are requested to read this manual carefully and follow the instructions. Please keep this manual in a handy place near the machine.

Important

Contents of this manual are subject to change without prior notice. In no event will the company be liable for direct, indirect, special, incidental, or consequential damages as a result of handling or operating the machine.

Warning:

Use of controls or adjustment or performance of procedures other than those specified in this manual might result in hazardous radiation exposure.

Trademarks

Microsoft®, Windows® and Windows NT® are registered trademarks of Microsoft Corporation in the United States and/or other countries.

Adobe®, PostScript®, Acrobat® and PageMaker® are registered trademarks of Adobe Systems Incorporated.

PCL® is a registered trademark of Hewlett-Packard Company.

AppleTalk, Apple, Macintosh, Mac and TrueType are registered trademarks of Apple Computer, Incorporated.

IPS-PRINT™ Printer Language Emulation Copyright© 2000, Oak Technology, Inc., All Rights Reserved.

Ethernet® is a registered trademark of Xerox Corporation.

Other product names used herein are for identification purposes only and might be trademarks of their respective companies. We disclaim any and all rights in those marks.

The proper names of the Windows operating systems are as follows:

- The product name of Windows® 95 is Microsoft® Windows® 95
- The product name of Windows® 98 is Microsoft® Windows® 98
- The product name of Windows® Me is Microsoft® Windows® Millennium Edition (Windows Me)
- The product name of Windows® XP are as follows:
Microsoft® Windows® XP Professional
Microsoft® Windows® XP Home Edition
- The product name of Windows® 2000 are as follows:
Microsoft® Windows® 2000 Advanced Server
Microsoft® Windows® 2000 Server
Microsoft® Windows® 2000 Professional
- The product name of Windows® NT are as follows:
Microsoft® Windows NT® Server 4.0
Microsoft® Windows NT® Workstation 4.0

Notes:

Some illustrations in this manual might be slightly different from the machine.

Certain options might not be available in some countries. For details, please contact your local dealer.

TABLE OF CONTENTS

Manuals for This Machine	1
How to Read This Manual	2

1. Getting Started

Features of This Machine.....	3
Printer Drivers for This Machine	4
Software and Utilities Included on the CD-ROM	6
Guide to This Machine.....	8
Control Panel	8
Display Panel	9
Connecting the Machine	12
Requirements.....	12
Connecting the Machine to the Host Using the Parallel Cable	13
Setting Paper on the Bypass Tray.....	14
Setting the Paper Size on the Display Panel	16

2. Installing the Printer Driver and Software

Installation Method	21
Quick Install.....	24
Installing the PCL 5c/RPCS™ Printer Driver	27
Installing the PCL 5c/RPCS™ Printer Driver	27
Setting Up Options	29
Installing the PostScript 3 Printer Driver.....	31
Windows 95/98/Me - Installing the PostScript 3 Printer Driver.....	31
Windows 2000/XP - Installing the PostScript 3 Printer Driver.....	33
Windows NT 4.0 - Installing the PostScript 3 Printer Driver.....	35
Mac OS - Installing the PostScript 3 Printer Driver and Utilities.....	38
Mac OS X - Installing the PostScript 3 Printer Driver.....	42
Installing the Printer Driver Using IEEE 1394.....	43
Printing with SCSI Print.....	43
Printing with IP over 1394	45
Installing the SmartNetMonitor for Client/Admin.....	48
Installing the Agfa Monotype Font Manager 2000	49
Using Adobe PageMaker Version 6.0, 6.5 or 7.0	50
INDEX.....	51

Manuals for This Machine

The following manuals describe the operational procedures and maintenance of this machine.

To enhance safe and efficient operation of this machine, all users should read and follow the instructions carefully.

❖ **General Settings Guide**

Provides an overview of the machine. This manual introduces the functions of the machine. It also introduces the options that allow you to use additional functions and describes how to access the system user tools to make the machine easier to use.

❖ **Copy Reference**

Describes procedures and functions for using this machine as a copier.

❖ **Printer/Scanner Kit Type 1232 Printer Reference 1**

Describes system settings, procedures and functions for using this machine as a printer (this manual).

❖ **Printer/Scanner Kit Type 1232 Printer Reference 2**

Describes procedures and provides information about using this machine as a printer. This manual is included as a PDF file on the CD-ROM labeled "Operating Instructions".

❖ **Network Printing Guide Operating Instructions**

Describes procedures and provides information about setting up and using the machine as a printer in a network environment. We recommend you read this manual first. It is included as a PDF file on the CD-ROM labeled "Operating Instructions" .

❖ **PostScript 3 Board Type 1232 Operating Instructions Supplement**

Describes menus and features you can set using the PostScript 3 printer driver. This manual is provided as a PDF file on the CD-ROM labeled "Operating Instructions".

Note

- Printing with the PostScript 3 printer driver is available when the PostScript 3 board option is installed on your machine.

❖ **UNIX Supplement**

Provides information about setting up and using the machine as a printer in a UNIX environment. For UNIX printing information, please visit our web site or consult your authorized dealer.

❖ **Scanner Reference**

Describes system settings, procedures and functions for using this machine as a scanner.

Note

- Scanner function is available when the Printer/Scanner option is installed on your machine.

How to Read This Manual

Symbols

In this manual, the following symbols are used:

WARNING:

This symbol indicates a potentially hazardous situation which, if instructions are not followed, could result in death or serious injury.

CAUTION:

This symbol indicates a potentially hazardous situation which, if instructions are not followed, may result in minor or moderate injury or damage to property.

* The statements above are notes for your safety.

Important

If this instruction is not followed, paper might be misfed, originals might be damaged, or data might be lost. Be sure to read this.

Preparation

This symbol indicates the prior knowledge or preparations required before operating.

Note

This symbol indicates precautions for operation, or actions to take after misoperation.

Limitation

This symbol indicates numerical limits, functions that cannot be used together, or conditions in which a particular function cannot be used.

Reference

This symbol indicates a reference.

[]

Keys and buttons that appear on the computer's display.

Keys that appear on the machine's panel display.

[]

Keys built into the machine's control panel.

Keys on the computer's keyboard.

1. Getting Started

Features of This Machine

This machine is designed especially for office workgroups, both for shared usage within a network environment, and for one-to-one usage connected directly to a computer.

❖ **Standard compatibility with Windows 95/98/Me, Windows 2000, Windows XP and Windows NT 4.0**

As the printer drivers for the above operating systems are included, it is possible to print to maximum capacity by using the special features of this machine.

❖ **Network Connectivity**

This machine can be used as a network printer.

It can print from any environment as it supports at the same time NetWare (TCP/IP, IPX/SPX), Windows 95/98/Me (TCP/IP, NetBEUI), Windows 2000 (TCP/IP, NetBEUI), Windows XP (TCP/IP), Windows NT 4.0 (TCP/IP, NetBEUI), UNIX (TCP/IP), and Macintosh (AppleTalk).

If you register the user code by using the client, you can keep track of printing jobs done under each code.

❖ **Use the Network Utilities included at your own convenience.**

When you use "SmartNetMonitor for Client" and "SmartNetMonitor for Admin" network utilities, you can parallel print, allowing you to scatter large amounts of print sets across multiple printers; or alternative print, which allows you to use another printer when you can not access the network printer you are trying to use. Also, while at your workstation, the machine will notify you when the print job is completed.

❖ **Complete Paper Handling Option**

When the optional finisher is connected, you can collate and staple.

❖ **Using the Document Server**

The document server stores files sent from the computer on the hard disk of the machine. Later, the printer settings can be configured and the files printed. Even when this machine is used as a network printer, passwords can be assigned to each file, providing a high level of security. Also, you can combine and print files scanned by this machine.

Printer Drivers for This Machine

Printing requires installation of a printer driver for your operating system. The following drivers are included on the CD-ROM labeled "Printer Drivers and Utilities" that comes with the printer/scanner option of this machine.

Printer Language	PCL 5c	RPCS™	PostScript 3
Operating system			
Windows 95 *1	√	√	√ *11
Windows 98 *2	√	√	√ *11
Windows Me *3	√	√	√ *11
Windows 2000 *4	√	√	√ *12
Windows XP *5	√	√	√ *12
Windows NT 4.0 *6	√ *9	√ *9	√ *10 *11
Mac OS *7			√ *11
Mac OS X *8			√ *13

*1 Microsoft Windows 95 operating system

*2 Microsoft Windows 98 operating system

*3 Microsoft Windows Millennium Edition

*4 Microsoft Windows 2000 Advanced Server
Microsoft Windows 2000 Server

Microsoft Windows 2000 Professional

*5 Microsoft Windows XP Professional
Microsoft Windows XP Home Edition

*6 Microsoft Windows NT Server operating system version 4.0, Microsoft Windows NT Workstation operating system version 4.0 in a computer using x86 processors.

*7 Versions 8.6 to 9.2 of the Mac OS (Mac OS X Classic mode is supported.)

*8 Mac OS X 10.1 or later (Native mode)

*9 Requires Service Pack 4 or later.

*10 Requires Service Pack 6 or later.

*11 The Adobe PostScript 3 printer drivers and PostScript Printer Description (PPD) files are included on the CD-ROM labeled "Printer Drivers and Utilities".

*12 The PostScript Printer Description (PPD) files are included on the CD-ROM labeled "Printer Drivers and Utilities".

*13 The Adobe PostScript Printer Description (PPD) installer is included on the CD-ROM labeled "Printer Drivers and Utilities".

◆ PCL 5c printer drivers

The PCL 5c printer drivers are included on the CD-ROM that comes with this machine. This printer driver allows the computer to communicate with the machine via a printer language.

⇒ p.27 "Installing the PCL 5c/RPCS™ Printer Driver"

❖ RPCS™ printer driver

The RPCS™ printer drivers are included on the CD-ROM that comes with this machine. This printer driver allows the computer to communicate with the machine via a printer language. The preset type user interface is provided in addition to the conventional one.

⇒ p.27 "Installing the PCL 5c/RPCS™ Printer Driver"

❖ Adobe PostScript 3 Printer Drivers and PPD files

The Adobe PostScript 3 printer drivers and the PPD files are included on the CD-ROM that comes with this machine. This printer driver allows the computer to communicate with the printer via a printer language. The PPD files allow the printer driver to enable the printer specific functions.

⇒ p.31 "Installing the PostScript 3 Printer Driver"

Software and Utilities Included on the CD-ROM

1

There are three CD-ROMs that come with the printer/scanner option of this machine.

Note

❑ The Printer/Scanner Kit Type 1232 package contains the following CD-ROMs:

- Printer Drivers and Utilities
- Scanner Driver and Document Management Utilities
- Operating Instructions

The CD-ROM labeled “Printer Drivers and Utilities” is mainly used for machine printer functions. In this manual, “CD-ROM” refers to the “Printer Drivers and Utilities” CD-ROM unless specified otherwise.

❖ **SmartNetMonitor for Admin**

This utility is for the system administrator to manage printers on the network.

Reference

See SmartNetMonitor for Admin online Help for more information about using the SmartNetMonitor for Admin.

❖ **SmartNetMonitor for Client**

This utility is for users to manage their own print status on the network.

Reference

See SmartNetMonitor for Client online Help for more information about using the SmartNetMonitor for Client.

❖ **LAN-Fax Driver**

This utility enables you to fax documents directly from your computer.

❖ **Address Book**

This utility enables you to easily store and recall names and numbers for use with the LAN-Fax utility.

❖ **Agfa Monotype Font Manager 2000**

This utility helps you to install new screen fonts, or organize and manage fonts already installed on the system.

❖ **1394 Utility**

This utility is for the IEEE 1394 Interface Unit. For more information, see the Readme file or the manual that comes with the IEEE 1394 Interface Unit option.

❖ **Acrobat Reader**

This utility allows you to read PDF (Portable Document Format).

 **Note**

- Documentation about using the machine is included on the CD-ROM in PDF format. See Acrobat Reader online Help for more information about using Acrobat Reader.

❖ **Printer Utility for Mac**

This utility allows users to download and manage a variety of fonts as well as to manage their printers. For more information about this utility, see the *PostScript 3 Board Type 1232 Operating Instructions Supplement* which is provided as a PDF file on the CD-ROM labeled “Operating Instructions”.

 **Important**

- Software and utilities must be uninstalled before installing newer versions of Windows. Reinstall software and utilities after upgrading Windows.

Guide to This Machine

1

Control Panel

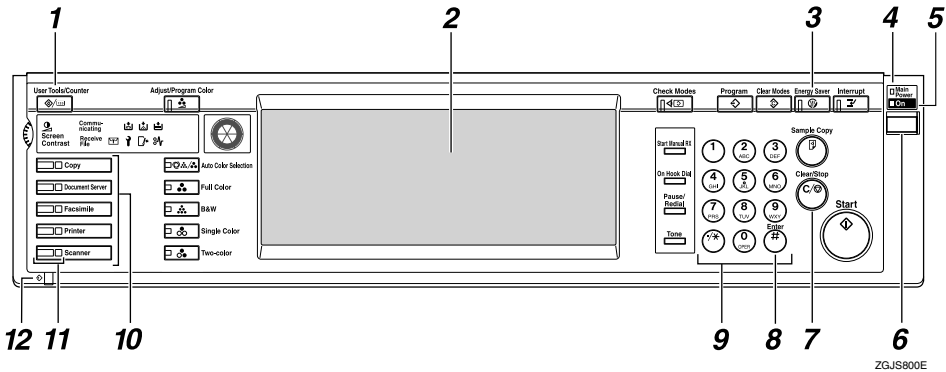

1. [User Tools/Counter/Inquiry] key

- User Tools
Press to change the default settings and conditions to meet your requirements.
- Counter
Press to display or print the total number of copies made.
- Inquiry
Press to check where to contact to have the machine repaired or to order toner.

2. Display panel

Shows operation status, error messages, and function menus. ⇒ p.9 “Display Panel”

3. [Energy Saver] key

Press to switch to and from the Energy Saver mode. See “ENERGY STAR Program”, *General Settings Guide* .

Note

- This key is ineffective during system setting (User Tools) operations.

4. Main power indicator

This indicator goes on when the main power switch is turned on.

Important

- Do not turn off the main power while the On indicator is blinking. Doing so may damage the hard disk.

5. On indicator

This indicator goes on when the operation switch is turned on.

6. Operation switch

Press this switch to turn the power on (the On indicator goes on). To turn the power off, press this switch again (the On indicator goes off).

7. [Clear/Stop] key

- Clear
Deletes one character or digit.
- Stop
Interrupts the current print job in progress.

8. [#] key

Press to enter a value.

9. Number keys

Use to enter the desired number of copies and data for selected modes.

10. Function keys

Press the appropriate key to choose any of the following functions:

- Copy
- Document Server
- Facsimile
- Printer
- Scanner

11. Function status indicator

These show the status of the above functions:

- Yellow: the function is selected.
- Green: the function is active.
- Red: the function has been interrupted.

12. Data In indicator

The Data In indicator shows the status of data reception from a computer.

- This indicator blinks when data is being received.
- This indicator goes on when there is data remaining to be printed.

Display Panel

The display panel shows the status of the machine, error messages and function menus.

Important

- Do not apply a strong shock or force of about 30 N ^{*1} (about 3 kgf ^{*2}) or more to the display panel. Otherwise, the display can get damaged.

^{*1} N = Newton

^{*2} kgf = Kilogram force (1kgf \doteq 9.8N)

Note

- The function items displayed serve as selector keys. You can select or specify an item by lightly pressing on it.
- When you select or specify an item on the display panel, it becomes highlighted.
- Keys dimmed (ex. ) cannot be used.

Displays and Key Operations

Note

- The screen displayed when the power is turned on is the copier screen which is the factory set default. This initial setting can be changed. See “User Tools (System Settings)”, *General Settings Guide*.
- The following illustrations are examples for the machine with the options installed. See “External Options”, *General Settings Guide*.

◆ Initial print display

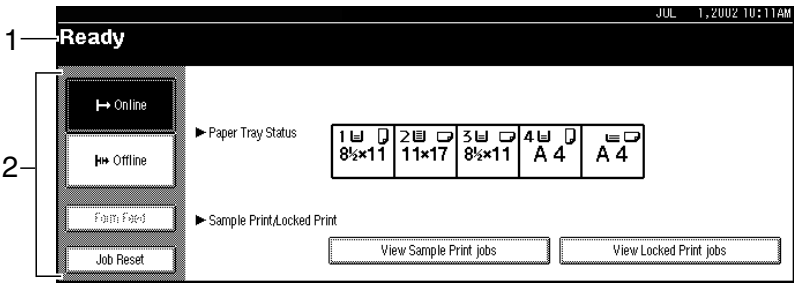

1. Operational status or messages

2. The current settings as well as the functions which can be selected are displayed.

Note

- The item which is currently selected or specified is highlighted.

Common Key Operation

The following keys can be used in all screens.

◆ Key explanations

[OK]	Acknowledges a selected function or entered values, and then returns to the previous screen.
[Cancel]	Deletes a selected function or entered values, and then returns to the previous screen.
[▲Prev.] [▼Next]	Moves to the previous page or the next page when all the functions cannot be displayed on one page.
[OK] [Yes]	Closes message screens.
[Clear]	Clears entered values and does not change the screen.
[Exit]	Returns to the previous screen.

Online

When the machine is online, it can receive data from the computer.

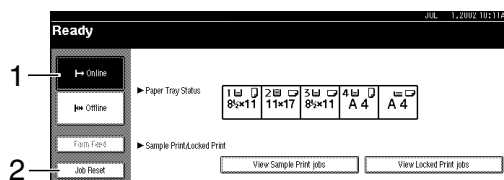

1. [Online] key

Press this key to switch the machine on-line. The preceding illustration shows the online status.

2. [Job Reset] key

Press this key to cancel the current print job.

Offline

When the machine is offline, it cannot receive data from the computer.

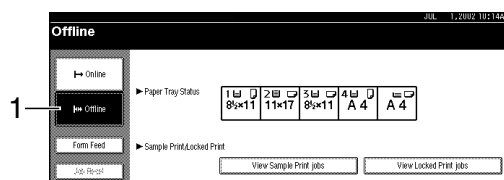

1. [Offline] key

Press this key to switch the machine offline. The preceding illustration shows the offline status.

Note

- ❑ If the machine cannot be switched to offline status, change the system setting of **[Signal Control]** to “Printer priority”. For details about the setting, see “User Tools (System Settings)”, *General Settings Guide*.
- ❑ When “Job acceptance priority” is set for the system setting of **[Signal Control]**, the machine accepts print jobs and facsimile transmissions from computers even when the offline status is indicated. For details about the setting, see “User Tools (System Settings)”, *General Settings Guide*.

Connecting the Machine

1

This section gives instructions for connecting the machine and computer using the parallel port.

Reference

For Ethernet and IEEE 1394 interface connections, see “Connecting to the Machine (Network Connections)”, *General Settings Guide*.

Requirements

Before using this machine, make sure that all the environmental and electrical requirements have been met. Connect the machine to the host computer using the parallel port, network interface unit, or both.

Make sure that all the cables, connectors, and electrical outlets necessary to attach the machine to the host computer or network are present.

Parallel cable requirements

Connect the machine to the host computer using a parallel port. This machine does not provide the parallel cable to connect the machine to the host computer.

The machine's parallel interface is a standard bidirectional interface. It requires a standard IEEE 1284 compliant 36-pin parallel cable and a parallel port on the host computer. Make sure to purchase the appropriate cable for the machine and your computer.

Note

- Do not use a parallel cable that is longer than 3 meters (10 feet).

Connecting the Machine to the Host Using the Parallel Cable

Connect the machine to the host computer using a parallel cable compliant with IEEE 1284 (supplied by you).

Follow the procedure below to connect the machine to the host computer.

Important

- Before connecting an interface cable between the machine and a computer, make sure that the machine is not operating, and then turn off the main power switch of the machine and computer.
- Be sure to use the designated interface cable. Using another cable may cause radio interference.

1 Turn off the main power switch.

Important

- Before turning off the main power switch, see “Turning Off the Power”, *General Settings Guide*.

2 Plug the 36-pin end of the parallel cable into the parallel port at the right side of the back cover of the machine.

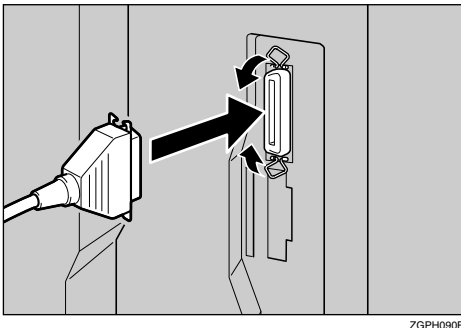

3 Squeeze the wire clips on each side of the connector together until they snap into place. The clips hold the cable securely in place.

4 Plug the other end of the parallel cable into the computer's parallel port.

Setting Paper on the Bypass Tray

This section gives instructions for setting paper on the optional bypass tray. Use the bypass tray to print onto OHP transparencies, labels, and envelopes that cannot be loaded in the paper tray.

Reference

For setting paper into the regular paper tray, see the *General Settings Guide*.

Note

- The paper size that can be set in the bypass tray:
 - Vertical: 90 - 297 mm (3.5 in. - 11.7 in.)
 - Horizontal: 148 - 432 mm (5.8 in. - 17 in.)
- Make sure to set the paper in landscape orientation  in the bypass tray.

Important

- When printing using the printer function, original images are always rotated by 180 degrees (the orientation of images to be printed is opposite to that of the copier function). When printing onto paper with specific orientation requirements, such as envelopes and letterheads, make sure to rotate the paper feed direction to 180 degrees.
- The following functions are disabled when printing from the bypass tray:
 - Duplex Printing
 - Auto Tray Select
 - Auto Tray Switching
- Make sure to set the paper size using the printer driver when printing data from the computer. The paper size set using the printer driver has priority over the one set using the display panel.
- Make sure to set the paper to landscape orientation  in the printer driver when printing data from the computer.

1 Open the bypass tray.

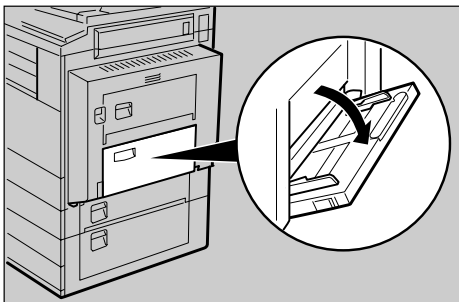

ZGPH100E

2 Adjust the paper guides to the paper size.

⚠ Important

- If the paper guides are not flush against the paper, skewed images or paper misfeeds might occur.

3 Gently insert the paper face down in the bypass tray until the beeper sounds.

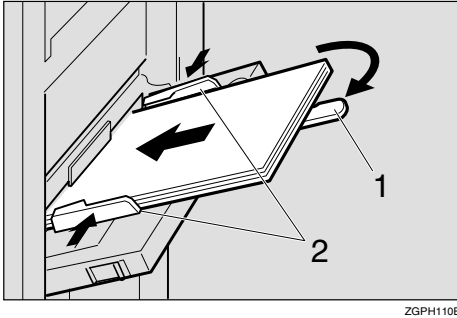

1. Extender

2. Paper guides

📌 Note

- The beeper will not sound if it is turned off. Gently insert the paper until it stops.
- Do not stack paper over the limit mark, otherwise a skewed image or paper misfeeds might occur.
- Open out the extender to support paper sizes larger than A4 , 8¹/₂"×11" .
- Fan the paper to get air between the sheets to avoid a multi-sheet feed.
- When setting an OHP transparency, make sure that its front and back sides are properly positioned.
- Select the paper type when printing on OHP transparencies or thick paper (over 105g/m²). For details, see p.18 "Setting thick paper or OHP transparencies".

4 Select the paper size.

📌 Note

- You can set paper size using the printer driver. The following procedures are not necessary when setting paper size using the printer driver.
- The paper size set using the printer driver has priority over that set using the display panel.
- When the printer driver is not used, make settings using the display panel.

🔍 Reference

For printer driver settings, see the printer driver's Help.

For setting custom sizes, see p.17 "Setting custom size paper"

Setting the Paper Size on the Display Panel

- 1 Press the **[User Tools/Counter/Inquiry]** key on the control panel.

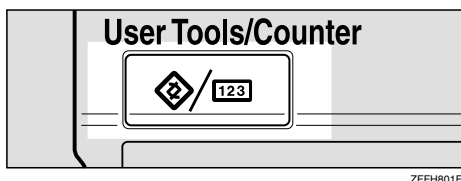

- 2 Press **[Printer Features]**.

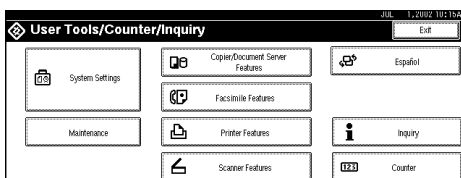

- 3 Press the **[Paper Input]** tab.

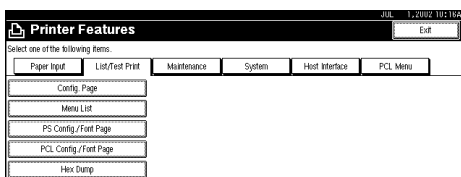

- 4 Press **[Bypass Paper Size]**.

- 5 Select the paper size.

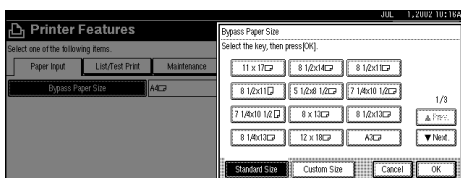

Note

- Press **[▲Prev.]** or **[▼Next]** to scroll through the list.
- When printing onto thick paper or OHP transparencies, select the paper type. For details, see p.18 "Setting thick paper or OHP transparencies".

- 6 Press **[OK]**.

- 7 Press the **[User Tools/Counter/Inquiry]** key.

Setting custom size paper

Note

- ❑ Custom sizes can also be set using the printer driver. The following procedures are not necessary when setting custom sizes using the printer driver.
- ❑ Custom size settings set using the printer driver have priority over those in the display panel on the machine.
- ❑ When the printer driver is not used, make settings using the display panel.

Reference

For printer driver settings, see the printer driver's Help.

- 1** Press the **[User Tools/Counter/Inquiry]** key on the control panel.

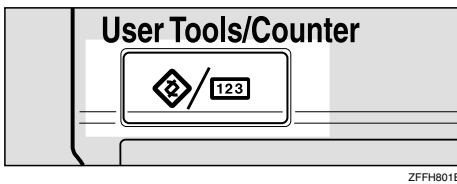

- 2** Press **[Printer Features]**.
- 3** Press the **[Paper Input]** tab.
- 4** Press **[Bypass Paper Size]**.
- 5** Press **[Custom Size]**.

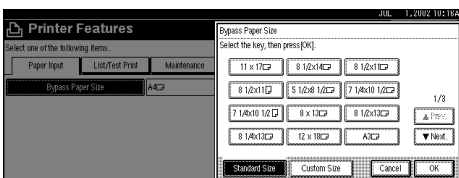

- 6** Enter the vertical size of the paper with the number keys, and then press **[#]**.

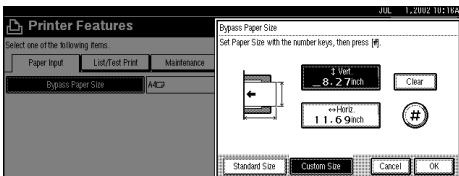

- 7** Enter the horizontal size of the paper with the number keys, and then press **[#]**.

- 8** Press **[OK]**.

The paper sizes you entered are displayed.

- 9** Press the **[User Tools/Counter/Inquiry]** key.

Setting thick paper or OHP transparencies

Note

- ❑ Paper settings can also be set using the printer driver. The following procedures are not necessary when setting paper sizes using the printer driver.
- ❑ Paper size settings set using the printer driver have priority over those in the display panel on the machine.
- ❑ When the printer driver is not used, make settings using the display panel.

Reference

For printer driver settings, see the printer driver's Help.

- 1** Press the **[User Tools/Counter/Inquiry]** key on the control panel.

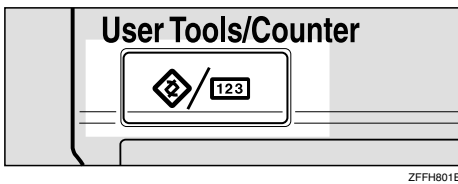

- 2** Press **[System Settings]**.

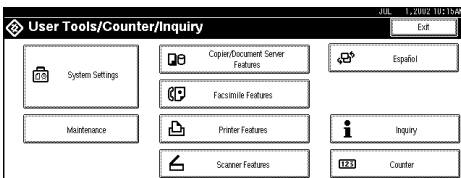

- 3** Press the **[Tray Paper Settings]** tab.

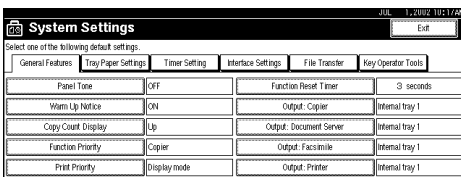

- 4** Press **[▼Next]** to scroll the list.

- 5** Press **[Paper Type : Bypass tray]**.

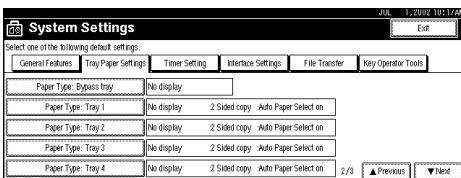

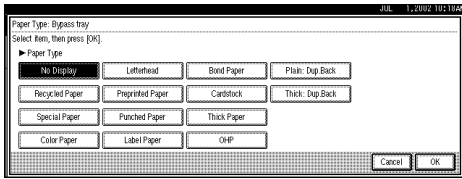
6 Select **[OHP]** or **[Thick Paper.]****7** Press **[OK]**.

The paper type you selected is displayed.

8 Press the **[User Tools/Counter/Inquiry]** key.**Note**

- The settings made will remain valid until they are reset again. After printing on OHP transparencies or thick paper, make sure to reset the settings for the next person.

2. Installing the Printer Driver and Software

This manual assumes that you are familiar with general Windows procedures and practices. If you are not, see the documentation that comes with Windows for details.

Installation Method

❖ Installing using Auto Run

Inserting the CD-ROM into the CD-ROM drive starts the installer automatically. The installer helps you install the following printer drivers and software easily.

The following table shows the printer drivers and software that can be installed using Auto Run.

	Auto Run *1		
	Quick Install		Add Printer and Utility Wizard
	Network connection with TCP/IP	Parallel connection	
PCL 5c printer driver	<input type="radio"/>	<input type="radio"/>	<input type="radio"/>
RPCS™ printer driver	<input type="radio"/>	<input type="radio"/>	<input type="radio"/>
PostScript 3 printer driver			<input type="radio"/>
Agfa Monotype Font Manager 2000			<input type="radio"/>
SmartNetMonitor for Admin			<input type="radio"/>
SmartNetMonitor for Client	<input type="radio"/>		<input type="radio"/>
LAN-Fax Driver			<input type="radio"/>
Address Book			<input type="radio"/>

*1 Available operating systems are as follows: Windows 95/98/Me, Windows 2000/XP, Windows NT 4.0. Auto Run is unavailable with Macintosh.

Reference

When the machine is connected to the computer using the IEEE 1394 interface, see p.43 "Installing the Printer Driver Using IEEE 1394" .

❖ Installing manually

The following printer drivers and software cannot be installed using Auto Run.

For Macintosh

- **PostScript 3 Printer Driver for Macintosh**
⇒ p.38 “Mac OS - Installing the PostScript 3 Printer Driver and Utilities”
- **PostScript Printer Descriptions Files (PPD)**
The PPD files for Mac OS 8.6 to 9.2, and Mac OS X are different.
⇒ p.38 “Mac OS - Installing the PostScript 3 Printer Driver and Utilities”
⇒ p.42 “Mac OS X - Installing the PostScript 3 Printer Driver”
- **Adobe Type Manager (ATM)**
⇒ p.40 “Installing Adobe Type Manager (ATM)”
- **Screen Fonts**
⇒ p.41 “Installing screen fonts”
- **ColorSync™ Profiles**
⇒ p.40 “Installing the ColorSync™ profile”
- **Printer Utility for Mac**
For installing the software, see the *PostScript 3 Board Type 1232 Operating Instructions Supplement*.

For Windows

- **1394 Utility**
For installing the utility, see the Readme file or the manual that comes with the IEEE1394 Interface Unit option.

⚠ Important

- Before starting the installation, close all documents and applications. In a network environment, make sure that users who are logged on are disconnected.
- After installing a printer driver, you must restart the computer.

📝 Note

- If “plug and play” is started, click **[Cancel]** in the **[New Hardware Found]**, **[Device Driver Wizard]** or **[Found New Hardware Wizard]** dialog box, and then insert the CD-ROM. The **[New Hardware Found]**, **[Device Driver Wizard]** or **[Found New Hardware Wizard]** dialog box appears depending on the system version of the Windows 95/98/Me, Windows 2000/XP.

 **User Codes**

User codes are eight digit codes that allow you to keep track of printing done under each code. To use this feature, the network administrator should assign user codes and inform users of them before they install the printer driver.

Use the following methods to enter a user code for registration:

- For the PCL 5c or PostScript3 printer driver, enter the user code on the **[Statistics]** tab in the Printer Properties dialog box.
- For the RPCS™ printer driver, click the **[Printer Configuration]** button on the **[Print Settings]** tab in the Printer Properties dialog box. A window opens. Click the **[User Code]** button in the opened window. A dialog box appears. Enter the user code in the dialog box.

 **Note**

- When using the RPCS™ printer driver, the user code cannot be changed once entered. To change an entered user code, uninstall the printer driver, reinstall it, and then enter a new user code.

 **Reference**

For more information about user codes, see “User Code”, *General Settings Guide*.

 **Additional Drivers (Alternate Drivers)**

If you want to share the machine on a Windows 2000/XP, Windows NT 4.0 platform, install the printer drivers of other versions of Windows as additional drivers, so that users running different versions of Windows can download them automatically when they connect.

 **Note**

- When using the “additional driver” function in the PostScript 3 printer driver with the Windows NT 4.0, Windows NT 4.0 Service Pack 6 or later is required. For the PCL 5c and RPCS™ printer drivers with Windows NT 4.0, Service Pack 4 or later is required.

For more information about installing the printer driver as an additional driver, see p.27 “Installing the PCL 5c/RPCS™ Printer Driver”, p.33 “Windows 2000/XP - Installing the PostScript 3 Printer Driver”, p.35 “Windows NT 4.0 - Installing the PostScript 3 Printer Driver”

Quick Install

Auto Run will start the installer automatically when you load the CD-ROM in the CD-ROM drive. By selecting Quick Install, you can easily install the PCL 5c printer driver and the RPCS™ printer driver. The SmartNetMonitor for Client can also be installed provided the machine and the computer are connected via the network.

2

The following conditions are required:

- Windows 95/98/Me, Windows 2000/XP or Windows NT 4.0

For Ethernet connections:

- The machine must be connected to the network using an Ethernet cable.
- TCP/IP protocol must be configured.
- The IP address must be assigned to both machine and computer.

For parallel connections:

- The machine must be connected to the computer using a parallel cable.
- Bidirectional transmission must be enabled.

Limitation

- If your operating system is Windows 2000/XP or Windows NT 4.0, installing a printer driver using Auto Run requires Administrators permission. When you install a printer driver using Auto Run, log on using an account that has Administrators permission.
- When the machine is connected to the computer using the IEEE 1394 interface, Quick Install cannot be used. See p.43 "Installing the Printer Driver Using IEEE 1394".

Important

- If your system is Windows NT 4.0, we recommend that you upgrade the Windows NT 4.0 operating system to Service Pack 4 or later before installing the PCL 5c or RPCS™ printer drivers. Contact your Windows retailer for more information about the latest version available.

Note

- If you want to cancel Auto Run, hold down the **[SHIFT]** key (when your operating system is Windows 2000/XP, hold down the left **[SHIFT]** key) while inserting the CD-ROM. Keep the **[SHIFT]** key held down until the computer has finished accessing the CD-ROM.

1 Close all applications that are running.

2 Insert the CD-ROM into the CD-ROM drive.

Auto Run will start the installer.

3 Select a language for the interface language, and then click **[OK]**.

The following languages are available: Cestina (Czech), Dansk (Danish), Deutsch (German), English (English), Espanol (Spanish), Francais (French), Italiano (Italian), Magyar (Hungarian), Nederlands (Dutch), Norsk (Norwegian), Polski (Polish), Portugues (Portuguese), Suomi (Finnish), Svenska (Swedish)

The default interface language is English.

4 Click **[Quick Install]**.

The software license agreement appears in the **[License Agreement]** dialog box.

5 After reading through all of the contents, click **[I accept the agreement]** to agree with the license agreement, and then click **[Next]**.

6 Click a model name of the machine you are using when the **[Select Printer]** dialog box appears.

 **Note**

- For a network connection with TCP/IP, select the machine whose IP address is displayed in **[Connect To]**.
- For parallel connection, select the machine whose printer port is displayed in **[Connect To]**.

7 Click **[Install]**.

8 Follow the instructions on the screen.

 **Note**

- During installation in Windows 2000, the **[Digital Signature Not Found]** dialog box may appear. In this case, click **[Yes]** to continue the installation.
- During installation in Windows XP, the **[Hardware Installation]** dialog box may appear. In this case, click **[Continue Anyway]** to continue the installation.

A message prompting you to restart your computer may appear. To complete the installation, restart your computer.

 **Important**

- If the machine is installed with the certain options, you should set the options using the printer driver. See p.29 "Setting Up Options"

 **Note**

- When you want to change the printer name, follow the procedure below.
 - **Windows 95/98/Me, Windows 2000, Windows NT 4.0**
Click **[Start]** on the taskbar, point to **[Settings]**, and then click **[Printers]**. The Printer window appears. Right-click the machine icon, and then select **[Rename]**.
 - **Windows XP Professional**
Click **[Start]** on the taskbar, and then **[Printers and Faxes]**. The Printers and Faxes window appears. Right-click the machine icon, and then select **[Rename]**.
 - **Windows XP Home Edition**
Click **[Start]** on the taskbar, and then **[Control Panel]**. Click **[Printers and Other Hardware]**, and then **[Printers and Faxes]**. The Printers and Faxes window appears. Right-click the machine icon, and then select **[Rename]**.

Installing the PCL 5c/RPCS™ Printer Driver

This section describes basic instructions for installing the PCL 5c printer driver and RPCS™ printer driver without using Quick Install. Also, procedures are described for setting up options installed on the machine using the printer driver. Follow the procedures below as appropriate.

Reference

See p.24 “Quick Install” for installing the PCL 5c printer driver or RPCS™ printer driver using Quick Install.

2

Installing the PCL 5c/RPCS™ Printer Driver

Limitation

- If your system is Windows 2000/XP or Windows NT 4.0, installing a printer driver using Auto Run requires Administrators permission. When you install a printer driver using Auto Run, log on using an account that has Administrators permission.

Important

- When updating to the latest version of the printer driver, you should uninstall former version, if any. See “Uninstalling the Printer Driver”, *Printer Reference 2*.
- If your system is Windows NT 4.0, we recommend that you upgrade the Windows NT 4.0 operating system to Service Pack 4 or later before installing the printer drivers. Contact your Windows retailer for more information about the latest version available.

Note

- If you want to share the machine on a Windows 2000/XP or Windows NT 4.0 platform, use the **[Sharing]** tab in the Printer Properties to specify the additional driver (alternate driver). For details, see the documentation that comes with Windows 2000/XP, or Windows NT 4.0.
- When prompted for the additional driver (alternate driver) location, select the following folders on the CD-ROM:
 - **Windows 95/98/Me**
PCL 5c: \DRIVERS\PCL5C\WIN9X_ME\ (Language)\DISK1\
RPCS™: \DRIVERS\RPCS\WIN9X_ME\ (Language)\DISK1\
 - **Windows 2000/XP**
PCL 5c: \DRIVERS\PCL5C\WIN2K_XP\ (Language)\DISK1\
RPCS™: \DRIVERS\RPCS\WIN2K_XP\ (Language)\DISK1\
 - **Windows NT 4.0**
PCL 5c: \DRIVERS\PCL5C\NT4\ (Language)\DISK1\
RPCS™: \DRIVERS\RPCS\NT4\ (Language)\DISK1\

1 Close all applications that are running.

2 Insert the CD-ROM into the CD-ROM drive.

Auto Run will start the installer.

3 Select a language for the interface language, and then click **[OK]**.

The following languages are available: Cestina (Czech), Dansk (Danish), Deutsch (German), English (English), Espanol (Spanish), Francais (French), Italiano (Italian), Magyar (Hungarian), Nederlands (Dutch), Norsk (Norwegian), Polski (Polish), Portugues (Portuguese), Suomi (Finnish), Svenska (Swedish)

The default interface language is English.

4 Click **[PCL/RPCS Printer Drivers]**.

The software license agreement appears in the **[License Agreement]** dialog box.

5 After reading through all of the contents, click **[I accept the agreement]** to agree with the license agreement, and then click **[Next]**.

6 Select the printer drivers you want to install when the **[Select Program]** dialog box appears, and then click **[Next]**.

7 Select the model of the machine you are using.

To change the printer name, change it in the **[Change settings for 'Printer Name']** box.

8 Double-click the machine name to display the printer settings.

 **Note**

- The details shown for **[Comment:]**, **[Driver:]** and **[Port:]** vary depending on the operating system being used, the model of machine selected, and the port being used.
- Confirm that **[LPT1:]** is selected for **[Port:]**.
- Check **[Default Printer]** if you want to set the machine as the default printer.
- Check **[Shared]** if you want to share the machine. See the *Network Printing Guide* for information about setting up and using the machine in a network environment.

9 Click **[Continue]** to start printer driver installation.

10 Follow the instructions on the screen.

 **Note**

- During installation in Windows 2000, the **[Digital Signature Not Found]** dialog box may appear. In this case, click **[Yes]** to continue the installation.
- During installation in Windows XP, the **[Hardware Installation]** dialog box may appear. In this case, click **[Continue Anyway]** to continue the installation.

Setting Up Options

If the machine is installed with certain options, you should set the options using the printer driver.

Limitation

- In Windows 2000/XP, changing the printer settings requires Manage Printers permission. Members of the Administrators and Power Users groups have Manage Printers permission by default. When you set up options, log on using an account that has Manage Printers permission.
- In Windows NT 4.0, changing the setting of the printer requires Full Control permission. Members of the Administrators, Server Operators, Print Operators, and Power Users groups have Full Control permission by default. When you set up options, log on using an account that has Full Control permission.

When setting up options, you should access the Printer Properties dialog box from Windows. You cannot set up options by accessing the Printer Properties dialog box from an application.

PCL 5c Printer Driver

1 Click **[Start]** on the taskbar, point to **[Settings]**, and then click **[Printers]**.

The **[Printers]** window appears.

Note

- In Windows XP Professional, access the **[Printers and Faxes]** window from **[Start]** on the taskbar.
- In Windows XP Home Edition, access the **[Printers and Faxes]** window by clicking **[Start]** on the taskbar. Then click **[Control Panel]**, **[Printers and Other Hardware]** and then **[Printers and Faxes]**.

2 Click the icon of the machine you want to use.

3 On the **[File]** menu, click **[Properties]**.

The Printer Properties window appears.

4 Click the **[Accessories]** tab.

5 Select the options you have installed from the **[Options]** group.

6 Click **[OK]**.

RPCS™ Printer Driver

- 1** Click **[Start]** on the taskbar, point to **[Settings]**, and then click **[Printers]**.

The **[Printers]** window appears.

 **Note**

- In Windows XP Professional, access the **[Printers and Faxes]** window from **[Start]** on the taskbar.
- In Windows XP Home Edition, access the **[Printers and Faxes]** window by clicking **[Start]** on the taskbar. Then click **[Control Panel]**, **[Printers and Other Hardware]** and then **[Printers and Faxes]**.

- 2** Click the icon of the machine you want to use.

- 3** On the **[File]** menu, click **[Properties]**.

The Printer Properties window appears.

 **Note**

- If the following message appears “Configure installed accessories in the **[Accessories]** tab of **[Printer Configuration]**, which will open next.”, click **[OK]** and then go to step **5**.

- 4** Click the **[Change Accessories]** tab.

 **Note**

- In Windows 95/98/Me, click **[Printer Configuration]** on the **[Print Settings]** tab, and then **[Change Accessories]**.

- 5** Select the options you have installed from the **[Select printer options]** group.

- 6** Click **[OK]**.

Installing the PostScript 3 Printer Driver

This section describes basic instructions for installing the PostScript 3 printer driver. Actual procedure may differ depending on the operating system. Follow the procedures below as appropriate.

Reference

To use the PostScript 3 printer driver, the optional PostScript 3 board must be installed on the machine. See the *PostScript 3 Board Type 1232 Operating Instructions Supplement* for details.

Important

- When updating to the latest version of the printer driver, you should uninstall any earlier versions. See “Uninstalling the Printer Driver”, *Printer Reference 2*.

Windows 95/98/Me - Installing the PostScript 3 Printer Driver

Installing the printer driver

1 Close all applications that are running.

2 Insert the CD-ROM into the CD-ROM drive.

Auto Run will start the installer.

3 Select a language for the interface language, and then click [OK].

The following languages are available: Cestina (Czech), Dansk (Danish), Deutsch (German), English (English), Espanol (Spanish), Francais (French), Italiano (Italian), Magyar (Hungarian), Nederlands (Dutch), Norsk (Norwegian), Polski (Polish), Portugues (Portuguese), Suomi (Finnish), Svenska (Swedish)

The default interface language is English.

Note

- The printer driver with the selected language will be installed.
- The printer driver will be installed in English if you select the following languages: Cestina, Magyar, Polski, Portugues and Suomi.

4 Select [PostScript 3 Printer Driver].

[Add Printer Wizard] starts.

5 Click [Next].

6 Check **[Local Printer]**, and then click **[Next]**.

A dialog box for selecting the printer appears.

7 Select the model of the machine you are using, and then click **[Next]**.

8 In the **[Available ports:]** box, click **[Printer Port]**, and then click **[Next]**.

9 Change the name of the machine if you wish to, and then click **[Next]**.

 **Note**

Check **[Yes]** if you want to set the machine as the default printer.

10 Follow the instructions on the screen.

Setting up options

If the machine is installed with certain options, you should set the options using the printer driver.

1 Click **[Start]** on the taskbar, point to **[Settings]**, and then click **[Printers]**.

The **[Printers]** window appears.

2 Click the icon of the machine you want to use.

3 On the **[File]** menu, click **[Properties]**.

The Printer Properties window appears.

4 Click the **[Accessories]** tab.

5 Select the options you have installed from the **[Options]** group.

6 Click **[OK]**.

Windows 2000/XP - Installing the PostScript 3 Printer Driver

Installing the printer driver

Limitation

- Installing a printer driver requires Administrators permission. When you install a printer driver, log on using an account that has Administrators permission.

Note

- If you want to share the machine on a Windows 2000/XP platform, use the **[Sharing]** tab in the Printer Properties to specify the additional driver (alternate driver). For details, see the documentation that comes with Windows 2000/XP.
- When prompted for the additional driver (alternate driver) location, select the following folders on the CD-ROM:
 - **Windows 95/98/Me:** \DRIVERS\PS\WIN9X_ME\ (Language)\DISK1\
 - **Windows NT 4.0:** \DRIVERS\PS\NT4\ (Language)\DISK1\

1 Close all applications that are running.

2 Insert the CD-ROM into the CD-ROM drive.

Auto Run will start the installer.

3 Select a language for the interface language, and then click **[OK]**.

The following languages are available: Cestina (Czech), Dansk (Danish), Deutsch (German), English (English), Espanol (Spanish), Francais (French), Italiano (Italian), Magyar (Hungarian), Nederlands (Dutch), Norsk (Norwegian), Polski (Polish), Portugues (Portuguese), Suomi (Finnish), Svenska (Swedish)

The default interface language is English.

Note

- The printer driver with the selected language will be installed.
- The printer driver will be installed in English if you select the following languages: Cestina, Magyar, Polski, Portugues and Suomi.

4 Select **[PostScript 3 Printer Driver]**.

[Add Printer Wizard] starts.

5 Click **[Next]**.

6 Check **[Local Printer]**, and then click **[Next]**.

Note

- In Windows XP, check **[Local printer attached to this computer]**, and then click **[Next]**.

A dialog box for selecting the printer port appears.

7 Select the check box of the port you want to use, and then click **[Next]**.

A dialog box for selecting the printer appears.

8 Select the model of the machine you are using, and then click **[Next]**.

9 Change the name of the machine if you wish to, and then click **[Next]**.

 **Note**

- Check **[Yes]** if you want to set the machine as the default printer.

10 Select whether or not you want to share the machine, and then click **[Next]**.

 **Reference**

See the *Network Printing Guide* for information about setting up and using the machine in a network environment.

11 Follow the instructions on the screen.

 **Note**

- During installation, the **[Digital Signature Not Found]** dialog box may appear. In this case, click **[Yes]** to continue the installation.
- During installation in Windows XP, the **[Hardware Installation]** dialog box may appear. In this case, click **[Continue Anyway]** to continue the installation.

Setting up options

If the machine is installed with certain options, you should set the options using the printer driver.

 **Limitation**

- Changing the printer settings requires Manage Printers permission. Members of the Administrators and Power Users groups have Manage Printers permission by default. When you set up options, log on using an account that has Manage Printers permission.

1 Click **[Start]** on the taskbar, point to **[Settings]**, and then click **[Printers]**.

The **[Printers]** window appears.

 **Note**

- In Windows XP Professional, access the **[Printers and Faxes]** window from **[Start]** on the taskbar.
- In Windows XP Home Edition, access the **[Printers and Faxes]** window by clicking **[Start]** on the taskbar. Then click **[Control Panel]**, **[Printers and Other Hardware]** and then **[Printers and Faxes]**.

2 Click the icon of the machine you want to use.

3 On the **[File]** menu, click **[Properties]**.

The Printer Properties window appears.

- 4** Click the [Device Settings] tab.
- 5** Select the options you have installed from the [Installable Options] group.
- 6** Click [OK].

Windows NT 4.0 - Installing the PostScript 3 Printer Driver

2

Installing the printer driver

Limitation

- Installing a printer driver requires Administrators permission. When you install a printer driver, log on using an account that has Administrators permission.

Important

- The CD-ROM containing the Windows NT Server operating system version 4.0, or the Windows NT Workstation operating system is required for installing the printer driver.
- We recommend that you upgrade the Windows NT 4.0 operating system to Service Pack 6 or later before installing the printer driver. Contact your Windows retailer for more information about the latest version available.

Note

- If you want to share the machine on Windows NT 4.0, use the [Sharing] tab in the Printer Properties to specify the additional driver (alternate driver). For details, see the documentation that comes with Windows NT 4.0.
- When prompted for the additional driver (alternate driver) location, select the following folders on the CD-ROM:
 - **Windows 95/98/Me:** \DRIVERS\PS\WIN9X_ME\ (Language)\DISK1\

1 Close all applications that are running.

2 Insert the CD-ROM into the CD-ROM drive.

Auto Run will start the installer.

3 Select a language for the interface language, and then click [OK].

The following languages are available: Cestina (Czech), Dansk (Danish), Deutsch (German), English (English), Espanol (Spanish), Francais (French), Italiano (Italian), Magyar (Hungarian), Nederlands (Dutch), Norsk (Norwegian), Polski (Polish), Portugues (Portuguese), Suomi (Finnish), Svenska (Swedish)

The default interface language is English.

Note

- The printer driver with the selected language will be installed.
- The printer driver will be installed in English if you select the following languages: Cestina, Magyar, Polski, Portugues and Suomi.

4 Select **[PostScript 3 Printer Driver]**.

[Add Printer Wizard] starts.

5 After confirming that the **[My Computer]** option is selected, click **[Next]**.

A dialog box for selecting the printer port appears.

6 Select the check box of the port you want to use, and then click **[Next]**.

A dialog box for selecting the printer appears.

7 Select the model of the machine you are using, and then click **[Next]**.

8 Change the name of the machine if you wish to, and then click **[Next]**.

 **Note**

Check **[Yes]** if you want to set the machine as the default printer.

9 Select whether or not you want to share the machine, and then click **[Next]**.

 **Reference**

See the *Network Printing Guide* for information about setting up and using the machine in a network environment.

10 Follow the instructions on the screen.

Setting up options

If the machine is installed with certain options, you should set the options using the printer driver.

 **Limitation**

Changing the printer settings requires Manage Printers permission. Members of the Administrators and Power Users groups have Manage Printers permission by default. When you set up options, log on using an account that has Manage Printers permission.

1 Click **[Start]** on the taskbar, point to **[Settings]**, and then click **[Printers]**.

The **[Printers]** window appears.

2 Click the icon of the machine you want to use.

3 On the **[File]** menu, click **[Properties]**.

The Printer Properties window appears.

4 Click the **[Device Settings]** tab.

5 Select the options you have installed from the **[Installable Options]** group.

6 Click **[OK]**.

Bidirectional transmission

When bidirectional transmission is enabled, information such as paper size and feed direction is automatically sent to the computer. You can also check the machine's status from your computer.

- Bidirectional transmissions are supported by Windows 95/98/Me, Windows 2000/XP and Windows NT 4.0.
- When bidirectional transmission is running, the machine status and information can be viewed by opening the printer driver screen.

To support bidirectional transmission, the following conditions are required:

❖ When connecting with a parallel cable

- The computer must support bidirectional transmission.
- The machine must be set to bidirectional transmission.
- The machine parallel port and computer parallel port are connected using a parallel interface cable that supports bidirectional transmission.

Note

- In Windows 95/98/Me, **[Enable bi-directional support for this printer]** must be selected in **[Spool Settings]** on the **[Details]** tab in RPCS™ printer driver.
- In Windows 2000/XP, or Windows NT 4.0, **[Enable bidirectional support]** must be selected, and **[Enable printer pooling]** must not be selected on the **[Port]** tab in RPCS™ printer driver.

❖ When connecting with the network

- The machine must be set to bidirectional transmission.
- SmartNetMonitor for Client included on the CD-ROM must be installed. One of the following conditions must also be satisfied besides the two requirements mentioned above.
- The port for SmartNetMonitor for Client and TCP/IP protocol must be used.
- The standard TCP/IP port is used without changing the port name (Windows 2000/XP).
- The IP address specified in the Microsoft TCP/IP Print is used (Windows NT 4.0).
- The IP address is included in port name when using IPP protocol.

Note

- In Windows 95/98/Me, **[Enable bi-directional support for this printer]** must be selected in **[Spool Settings]** on the **[Details]** tab in RPCS™ printer driver.
- In Windows 2000/XP, or Windows NT 4.0, **[Enable bidirectional support]** must be selected, and **[Enable printer pooling]** must not be selected on the **[Port]** tab in RPCS™ printer driver.

◆ When connecting with IEEE 1394

- The port on the optional IEEE 1394 Interface Unit and the IEEE 1394 port on the computer are connected using an interface cable (Windows Me, Windows 2000/XP).

Note

- [SCSI print (SBP-2)] must be set to “Active” and [Bidirectional SCSI print] must be set to “On” in [IEEE 1394] on the [Interface Settings] tab in the machine's System Settings.
- In Windows Me, [Enable bi-directional support for this printer] must be selected in [Spool Settings] on the [Details] tab in RPCS™ printer driver.
- In Windows 2000/XP, or Windows NT 4.0, [Enable bidirectional support] must be selected, and [Enable printer pooling] must not be selected on the [Port] tab in RPCS™ printer driver.

Mac OS - Installing the PostScript 3 Printer Driver and Utilities

It is necessary to install a printer driver and a PPD file to print from a Macintosh. Follow the procedures to install a printer driver and a PPD file on Macintosh running OS 8.6 or later version up to 9.2, and Mac OS X Classic mode.

Note

- For installing the PostScript 3 printer driver in Mac OS X, see p.42 “Mac OS X - Installing the PostScript 3 Printer Driver”

1 Insert the CD-ROM into the CD-ROM drive.

2 Double-click the CD-ROM icon.

3 Double-click the [Mac OS 8 and 9] folder.

4 Double-click the [PS Driver] folder.

5 Double-click the folder of the language you use.

6 Open [Disk 1] and double-click the installer icon.

The PostScript 3 printer driver installer window appears.

7 Follow the instructions on the screen.

8 Double-click [Extensions] in [System Folder].

9 Double-click [Printer Descriptions].

10 Double-click the CD-ROM icon on the desktop.

11 Double-click the [Printer Descriptions] folder in the [Mac OS 8 and 9] folder.

- 12** Double-click **[Disk 1]** in the folder of the language you use.
- 13** Drag the PPD file into **[Printer Descriptions]** in **[Extensions]** in **[System Folder]**.
- 14** Drag the plugin file into **[Printer Descriptions]** in **[Extensions]** in **[System Folder]**.
- 15** Restart the Macintosh.

Setting up the PPD File

Preparation

Make sure that the machine is connected to an AppleTalk network before performing the following procedure.

- 1** On the Apple menu, select **[Chooser]**.
- 2** Click the **[Adobe PS]** icon.
- 3** In the **[Select a PostScript Printer:]** list, click the name of the machine you want to use.
- 4** Click **[Setup]**.
- 5** Click the printer description file you want to use, and then click **[Select]**.

The PPD file is set up, and the **[Adobe PS]** icon appears at the left of the machine name in the list. Next, follow the procedure on p.39 “Setting up options” to make the option settings, or close the **[Chooser]** dialog box.

Setting up options

- 1** On the Apple menu, select **[Chooser]**.
- 2** Click the **[Adobe PS]** icon.
- 3** In the **[Select the PostScript Printer:]** list, click the name of the machine you want to use, and then click **[Setup]**.

- 4** Click **[Configure]**.

A list of options appears.

- 5** Select the options you want to set up and select the appropriate setting for it.

Note

If the option you want to set up is not displayed, the PPD file might not be set up correctly. Check the name of the PPD file shown in the dialog box.

- 6** Click **[OK]**.

The list of options closes.

7 Click [OK].

The [Chooser] dialog box appears.

8 Close the [Chooser] dialog box.

Installing the ColorSync™ profile

2

ColorSync profile makes it possible for the printer to print colors of similar intensity to those on the computer display. Follow the procedures below to install ColorSync profile.

 **Note**

- ColorSync profile complies to color standards as defined by the International Color Consortium (ICC).
- Some computer displays may require particular settings to be compatible with ColorSync. See the documentation that comes with your display for more information.

1 Start the Macintosh.

2 Double-click the hard disk icon, and then open the appropriate folder for installing the ColorSync profile.

 **Note**

- The location of the appropriate folder may differ depending on the version of the operating system. These are examples:
 - System\Preferences\ColorSync profiles
 - System\ColorSync profiles

3 Insert the CD-ROM into the CD-ROM drive.

4 Double-click the CD-ROM icon.

5 Double-click the [Mac OS 8 and 9] folder.

6 Double-click the [ColorSync Profiles] folder.

7 Drag the file to the [ColorSync Profiles] folder on the hard disk.

The ColorSync profile is installed.

Installing Adobe Type Manager (ATM)

 **Note**

- Close all applications that are running before installation. Install after restarting.

1 Start the Macintosh.

2 Insert the CD-ROM into the CD-ROM drive.

3 Double-click the CD-ROM icon.

4 Double-click the [Mac OS 8 and 9] folder.

5 Double-click the [ATM] folder.

6 Double-click the [ATM 4.6.2 installer] icon.

7 Follow the instructions on screen.

8 Restart the Macintosh.

 **Note**

- Make sure to restart the computer. ATM will be completely installed only after restarting.

9 Select [Control Panel] from the Apple menu, and then select [ATM].

10 Open the ATM control panel.

 **Note**

- For more information about installation, see the User's Guide in the ATM folder.

Installing screen fonts

1 Start the Macintosh.

2 Insert the CD-ROM into the CD-ROM drive.

3 Double-click the CD-ROM icon.

4 Double-click the [Mac OS 8 and 9] folder.

5 Double-click the [Fonts] folder.

6 Copy the fonts you want to install into the [System] folder.

A confirmation dialog box appears.

7 Click [OK].

The fonts are installed.

8 Restart the Macintosh.

 **Reference**

For information about installing the Printer Utility for Mac, see the *PostScript 3 Board Type 1232 Operating Instructions Supplement*.

Mac OS X - Installing the PostScript 3 Printer Driver

It is necessary to install a PPD file to print from a Macintosh. Follow the procedures to install a PPD file on Macintosh running Mac OS X.

Preparation

You need an administrator name and a password (phrase). For more information, consult your administrator.

- 1** Insert the CD-ROM into the CD-ROM drive.
- 2** Double-click the CD-ROM icon.
- 3** Double-click the [Mac OS X] folder.
- 4** Double-click the [PPD Installer] folder, and then double-click the installer icon.
- 5** Follow the instructions on screen.

Setting Up the PPD File

- 1** Run Print Center.
- 2** Click [Add Printer].
 -  **Note**
 - Select [AppleTalk] in the first pop-up menu.
 - If the zone has been set, select the zone in the second pop-up menu.
- 3** Select the PPD file for the model you are using from the “Printer Model:” pop-up menu.
- 4** Click [Add].

Setting Up Options

Limitation

- You cannot make printer option settings in Mac OS X. Do not make settings for options that have not been installed.

Installing the Printer Driver Using IEEE 1394

This section gives basic instructions for installing printer drivers using IEEE 1394. SCSI print and IP over 1394 are available when printing via IEEE 1394. The printer drivers can be installed from the CD-ROM that comes with this machine.

Preparation

Be sure that all other applications are closed and the computer is not printing before installation.

Important

- Do not connect new IEEE 1394 devices to the machine or turn on the machine while installing the printer driver.
- Before uninstalling the printer driver, be sure to disconnect the IEEE 1394 interface cable from the computer.
- The optional IEEE 1394 Interface Unit is not supported by Windows 95/98 or Windows NT 4.0. If the “plug and play” function starts, click **[Cancel]** in the **[New Hardware Found]** or **[Device Driver Wizard]** dialog box.

Printing with SCSI Print

Printing using a SCSI print device with the optional 1394 Interface Unit is possible under Windows 2000 or Windows XP.

Preparation

“SCSI print” must be enabled and “IP over 1394” must be disabled from the machine's display panel. For more information about how to make machine settings, see “Interface Settings/IEEE 1394 (Option)”, *General Settings Guide*.

Note

- If **[Found New Hardware Wizard]** appears every time the computer is started or the cable is connected with Windows 2000 or Windows XP when the print function that uses SCSI print is not installed, disable the device. See p.46 “Disabling the Device” for more information.

Installing the Printer Driver

Note

- If you send data from your computer when data is being received from another client computer, your data will be printed after completing the print job from the other client computer.
- When the machine is connected to the computer properly via the 1394 interface, the appearance of the icon in the printer window changes.

Windows 2000

Important

- In Windows 2000, the optional IEEE 1394 Interface Unit can only be used with Service Pack 1 or later. If the Service Pack is not installed, the connectable number of devices in a IEEE 1394 bus is only one, and the client cannot access the IEEE 1394 Interface Unit without using an account that has Administrators permission.

1 Connect the machine and the computer using the IEEE 1394 interface cable.

The **[Found New Hardware Wizard]** dialog box appears.

2 Click **[Next]**.

The message **[This wizard will complete the installation for this Device: Unknown]** appears.

3 Select **[Optional search locations:]**, and then click **[Next]**.

4 When the **[Locate Driver Files]** message appears, check the **[Optional search locations.]** checkbox and the **[Specify a location]** checkbox, and then click **[Next]**.

5 Hold down the left **[SHIFT]** key on the keyboard and insert the CD-ROM into the CD-ROM drive.

Keep the left **[SHIFT]** key held down until the computer has finished accessing the CD-ROM.

If the Auto Run program starts, click **[Cancel]**, and then **[Exit]**.

6 Click **[Browse]**.

7 Select the printer driver you want to install. Each printer driver is stored in the following folders:

- **RPCS™:** \DRIVERS\RPCS\WIN2K_XP*(Language)*\DISK1
- **PCL 5c:** \DRIVERS\PCL5C\WIN2K_XP*(Language)*\DISK1
- **PostScript 3:** \DRIVERS\PS\WIN2K_XP*(Language)*\DISK1

8 Click **[Open]**.

9 Click **[OK]**.

A printer model selection dialog box appears.

10 Follow the instructions on the screen.

Note

- During installation, the **[Digital Signature Not Found]** dialog box may appear. In this case, click **[Yes]** to continue the installation.
- When the installation is complete, the printer with its port directed to "1394_00n" appears on the **[Printers]** folder. ("n" is the number of printers connected.)

Windows XP

- 1** Connect the machine and the computer using the IEEE 1394 interface cable. The **[Found New Hardware Wizard]** dialog box appears.
- 2** Confirm that **[This wizard helps you install software for: (printer name)]** is displayed, and select **[Install from a list on specific location (Advanced)]**, and then click **[Next]**.
The message **[Please choose your search and installation option.]** appears.
- 3** Check the **[Search for the best driver in these locations.]** check box, and the **[Include this location in the search:]** check box.
- 4** Install the printer driver following the same procedures as steps **5-10** in Windows 2000.

Note

- During installation in Windows XP, the **[Hardware Installation]** dialog box may appear. In this case, click **[Continue Anyway]** to continue the installation.
- When the installation is complete, the printer with its port directed to "1394_00n" appears on the **[Printers and Faxes]** folder. ("n" is the number of printers connected.)

Printing with IP over 1394

You can print by setting the IP address for this machine and the computer on which Windows Me (SmartNetMonitor for Client) or Windows XP (SmartNetMonitor for Client or Standard TCP/IP Port) is installed.

Preparation

"IP over 1394" must be enabled on the machine's display panel and an IP address for the IEEE 1394 must be configured. For more information about how to make machine settings, see "Interface Settings/IEEE 1394 (Option)", *General Settings Guide*.

Limitation

- When using the IEEE 1394 (IP over 1394) interface in a network, the Ethernet interface cannot be used in the same network.

Note

- Make sure that the IEEE 1394 interface and Ethernet interface subnet mask range do not overlap.
- In Windows Me, if **[Found New Hardware Wizard]** appears every time the computer is started or the cable is connected, disable the device. See p.46 "Disabling the Device" for more information.

 **Disabling the Device**

❖ If [Add New Hardware Wizard] appears every time you restart the computer with an operating system that does not support SCSI print, or plug in/take out the cable, disable the device by the following procedures.

- Windows Me

- ① In the [Add New Hardware Wizard] dialog box, confirm that [Windows has found the following new Hardware: IEEE SBP-2 Device] is displayed, and select [Recommended search for a better driver [Recommended]], and then click [Next].
- ② When the [Windows was unable to locate the software for this device.] message appears, click [Finish].

❖ If you do not want to install the printer when [Found New Hardware Wizard] starts with an operating system that supports SCSI print, disable the device by the following procedures.

- Windows XP

- ① In the [Found New Hardware Wizard] dialog box, confirm that [This wizard helps you install software for: Unknown] is displayed, and select [Install from a list on specific location (Advanced)], and then click [Next].
- ② When the [Please choose your search and installation option.] message appears, remove all the selections from [Search for the best driver in these locations.], and then click [Next].
- ③ When the [The wizard could not find the software on your computer for..] message appears, click [OK].
- ④ When the [Cannot Install this Hardware] message appears, select the [Don't prompt again to install the software] check box, and then click [Finish].

- Windows 2000

- ① In the [Found New Hardware Wizard] dialog box, click [Next].
- ② When the [This wizard will complete the installation for this Device: Unknown] message appears, select [Search for a suitable driver for my device [recommended]], and then click [Next].
- ③ When the [Locate Driver Files] message appears, remove all the selections from [Optional search locations.], and then click [Next].
- ④ When the [Driver Files Search Results] message appears, select the [Disable the device. The Add/Remove Hardware Wizard in the control Panel can be able to complete the driver installations.] check box, and then click [Finish].

❖ If **[Found New Hardware Wizard]** appears every time you restart the computer with an operating system that does not support IP over 1394 or plug in/take out the cable, disable the device with the following procedure.

- Windows 2000

- ① In **[Found New Hardware Wizard]** dialog box, click **[Next]**.
- ② When the **[This wizard will complete the installation for this Device:]** message and “IP over 1394” appear, select **[Search for a suitable driver for my device [recommended]]**, and then click **[Next]**.
- ③ When the **[Locate Driver Files]** message appears, remove all the selections from **[Optional search locations.]**, and then click **[Next]**.
- ④ When the **[Driver Files Search Results]** message appears, select the **[Disable the device. The Add/Remove Hardware Wizard in the Control Panel can be able to complete the driver installations.]** check box, and then click **[Finish]**.



Installing the SmartNetMonitor for Client/Admin

! Limitation

- ❑ If your operating system is Windows 2000/XP or Windows NT 4.0, installing software using Auto Run requires Administrators permission. When you install a printer driver using Auto Run, log on using an account that has Administrators permission.

1 Close all applications that are running.

2 Insert the CD-ROM into the CD-ROM drive.

Auto Run will start the installer.

3 Select a language for the interface language, and then click [OK].

The following languages are available: Cestina (Czech), Dansk (Danish), Deutsch (German), English (English), Espanol (Spanish), Francais (French), Italiano (Italian), Magyar (Hungarian), Nederlands (Dutch), Norsk (Norwegian), Polski (Polish), Portugues (Portuguese), Suomi (Finnish), Svenska (Swedish)

The default interface language is English.

4 Click [SmartNetMonitor for Client/Admin].

The software license agreement appears in the [License Agreement] dialog box.

5 After reading through all of the contents, click [I accept the agreement] to agree with the license agreement, and then click [Next].

6 Select the program you want to install when the [Select Program] dialog box appears.

7 Follow the instructions on the screen.

Installing the Agfa Monotype Font Manager 2000

! Limitation

- If your operating system is Windows 2000/XP or Windows NT 4.0, installing software using Auto Run requires Administrators permission. When you install a printer driver using Auto Run, log on using an account that has Administrators permission.

1 Close all applications that are running.

2 Insert the CD-ROM into the CD-ROM drive.

Auto Run will start the installer.

3 Select a language for the interface language, and then click [OK].

The following languages are available: Cestina (Czech), Dansk (Danish), Deutsch (German), English (English), Espanol (Spanish), Francais (French), Italiano (Italian), Magyar (Hungarian), Nederlands (Dutch), Norsk (Norwegian), Polski (Polish), Portugues (Portuguese), Suomi (Finnish), Svenska (Swedish)

The default interface language is English.

4 Select [Agfa Monotype Font Manager 2000].

5 Follow the instructions on the screen.

Using Adobe PageMaker Version 6.0, 6.5 or 7.0

2

If you use the machine under Windows 95/98/Me, Windows 2000/XP or Windows NT 4.0 with Adobe PageMaker, you need to copy the PPD file to the PageMaker folder.

The PPD file is the file with extension “.ppd” in the folder “DRIVERS\PS\WIN9X_ME \ (Language) \ DISK1 \” on the CD-ROM.

The “WIN9X_ME” folder, inside the “PS” folder is for Windows 95/98/Me. Use the folder at this level that is appropriate for the operating system you are currently using.

The third folder, “(Language)” may be substituted by an appropriate language name.

Copy the file with extension “.ppd” to the PageMaker folder.

- **For PageMaker 6.0 default installation**
The directory is “C:\PM6\RSRC\PPD4”.
- **For PageMaker 6.5 default installation**
The directory is “C:\PM65\RSRC\USENGLISH\PPD4”.
The “USENGLISH” may vary depending on your language selection.
- **For PageMaker 7.0 default installation**
The directory is “C:\PM7\RSRC\USENGLISH\PPD4”.
The “USENGLISH” may vary depending on your language selection.

INDEX

1394 Utility, 6, 22

A

Acrobat Reader, 7
Additional driver, 23
Address Book, 6, 21
Agfa Monotype Font Manager 2000, 6, 21
 installing, 49
Alternate Driver, 23
ATM, 22
 Macintosh, installing, 40
Auto Run, 21

B

Bidirectional transmission, 37
Bypass tray, 14

C

CD-ROM, 6
Clear/Stop key, 8
ColorSync™ profiles, 22
 Macintosh, installing, 40
Connection
 Ethernet board connection, 12
 IEEE 1394 interface unit connection, 12
 Parallel interface connection, 12
Control Panel, 8
Custom size paper, 17
 printing, bypass tray, 14

D

Display panel, 8, 9

E

Energy Saver key, 8

F

Function keys, 9
Function status indicator, 9

I

IEEE 1394, 43
IP over 1394, 43

J

Job Reset key, 11

L

LAN-Fax Driver, 6, 21

M

Macintosh
 ATM, installing, 40
 ColorSync™ profile, installing, 40
 Screen fonts, installing, 41
Mac OS
 PostScript 3, installing, 38
Mac OS X
 PostScript 3, installing, 42
Main power indicator, 8
⇨Data In indicator, 9

N

Number keys, 9

O

Offline, 11

Offline key, 11

OHP Transparencies

printing, bypass tray, 18

On indicator, 8

Online, 11

Online key, 11

Operation switch, 8

P

PageMaker, 50

Parallel Cable, 12

PCL 5c, 4

Windows 2000/Windows XP,
installing, 27

Windows 95/98/Me, installing, 27

Windows NT 4.0, installing, 27

PostScript 3, 5

Mac OS, installing, 38

Mac OS X, installing, 42

Windows 2000/Windows XP,
installing, 33

Windows 95/98/Me, installing, 31

Windows NT 4.0, installing, 35

Printer driver

Installation method, 21

PCL 5c, 4

PostScript 3, 4

Quick Install, 24

RPCS, 4

Printer Utility for Mac, 7, 22

Q

Quick Install, 24

R

RPCS, 5

Windows 2000/Windows XP,
installing, 27

Windows 95/98/Me, installing, 27

Windows NT 4.0, installing, 27

S

Screen fonts, 22

Macintosh, installing, 41

SCSI print, 43

SmartNetMonitor for Admin, 6, 21, 48

SmartNetMonitor for Client, 6, 21, 48

Software

Quick Install, 24

T

Thick Paper

printing, bypass tray, 18

U

User Code, 23

User Tools/Counter/Inquiry key, 8

W

Windows 2000/Windows XP

IEEE 1394, installing printer driver, 43

PCL 5c, installing, 27

PostScript 3, installing, 33

RPCS, installing, 27

Windows 95/98/Me

PCL 5c, installing, 27

PostScript 3, installing, 31

RPCS, installing, 27

Windows NT 4.0

PCL 5c, installing, 27

PostScript 3, installing, 35

RPCS, installing, 27

MEMO

Note to users in the United States of America

Notice:

This equipment has been tested and found to comply with the limits for a Class B digital device, pursuant to Part 15 of the FCC Rules. These limits are designed to provide reasonable protection against harmful interference in a residential installation. This equipment generates, uses and can radiate radio frequency energy and, if not installed and used in accordance with the instructions, may cause harmful interference to radio communications.

However, there is no guarantee that interference will not occur in a particular installation. If this equipment does cause harmful interference to radio or television reception, which can be determined by turning the equipment off and on, the user is encouraged to try to correct the interference by one more of the following measures:

Reorient or relocate the receiving antenna.

Increase the separation between the equipment and receiver.

Connect the equipment into an outlet on a circuit different from that to which the receiver is connected.

Consult the dealer or an experienced radio/TV technician for help.

Caution (in case of IEEE1284 environment) :

Properly shielded and grounded cables and connectors must be used for connections to host computer (and/or peripheral) in order to meet FCC emission limits.

Caution (in case of 100BaseTX environment):

Network interface cable with ferrite core must be used for RF interference suppression.

Declaration of Conformity

Product Name: Printer Controller

Model Number: Printer Kit Type 1232, Printer/Scanner Kit Type 1232

Responsible party: Ricoh Corporation

Address: 5 Dedrick Place, West Caldwell, NJ 07006

Telephone number: 973-882-2000

This device complies with part 15 of FCC Rules.

Operation is subject to the following two conditions:

1. This device may not cause harmful interference, and
2. this device must accept any interference received, including interference that may cause undesired operation.

Note to users in Canada

Note:

This Class B digital apparatus complies with Canadian ICES-003.

Remarque concernant les utilisateurs au Canada

Avertissement:

Cet appareil numérique de la classe B est conforme à la norme NMB-003 du Canada.

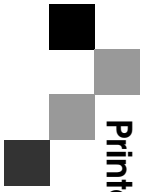

Printer/Scanner Kit Type 1232 Operating Instructions Printer Reference 1